

# **Agilent E5071C ENA Series RF Network Analyzers**

## **Installation Guide**

**Third Edition**



**Manufacturing No. E5071-90020**

**August 2007**

---

## Notices

The information contained in this document is subject to change without notice.

This document contains proprietary information that is protected by copyright. All rights are reserved. No part of this document may be photocopied, reproduced, or translated to another language without the prior written consent of Agilent Technologies.

Microsoft®, MS-DOS®, Windows®, Visual C++®, Visual Basic®, VBA® and Excel® are registered trademarks of Microsoft Corporation.

Java® is registered trademark of Sun Microsystems Corporation.

© Copyright 2006, 2007 Agilent Technologies

---

## Manual Printing History

The manual's printing date and part number indicate its current edition. The printing date changes when a new edition is printed (minor corrections and updates that are incorporated at reprint do not cause the date to change). The manual part number changes when extensive technical changes are incorporated.

|              |                |
|--------------|----------------|
| October 2006 | First Edition  |
| April 2007   | Second Edition |
| August 2007  | Third Edition  |

---

## Safety Summary

The following general safety precautions must be observed during all phases of operation, service, and repair of this instrument. Failure to comply with these precautions or with specific WARNINGS elsewhere in this manual may impair the protection provided by the equipment. Such noncompliance would also violate safety standards of design, manufacture, and intended use of the instrument. Agilent Technologies assumes no liability for the customer's failure to comply with these precautions.

---

### NOTE

The E5071C complies with INSTALLATION CATEGORY II as well as POLLUTION DEGREE 2 in IEC61010-1. The E5071C is an INDOOR USE product.

---

### NOTE

The LEDs in the E5071C are Class 1 in accordance with IEC60825-1, CLASS 1 LED PRODUCT

- Ground the Instrument  
To avoid electric shock, the instrument chassis and cabinet must be grounded with the supplied power cable's grounding prong.
- DO NOT Operate in an Explosive Atmosphere  
Do not operate the instrument in the presence of inflammable gasses or fumes. Operation of any electrical instrument in such an environment clearly constitutes a safety hazard.
- Keep Away from Live Circuits  
Operators must not remove instrument covers. Component replacement and internal adjustments must be made by qualified maintenance personnel. Do not replace components with the power cable connected. Under certain conditions, dangerous voltage levels may remain even after the power cable has been disconnected. To avoid injuries, always disconnect the power and discharge circuits before touching them.
- DO NOT Service or Adjust the Instrument Alone  
Do not attempt internal service or adjustment unless another person, capable of rendering first aid and resuscitation, is present.
- DO NOT Substitute Parts or Modify the Instrument  
To avoid the danger of introducing additional hazards, do not install substitute parts or perform unauthorized modifications to the instrument. Return the instrument to an Agilent Technologies Sales and Service Office for service and repair to ensure that safety features are maintained in operational condition.
- Dangerous Procedure Warnings  
Warnings, such as the example below, precede potentially dangerous procedures throughout this manual. Instructions contained in the warnings must be followed.

---









### WARNING

**Dangerous voltage levels, capable of causing death, are present in this instrument. Use extreme caution when handling, testing, and adjusting this instrument.**

---

## Safety Symbols

General definitions of safety symbols used on the instrument or in manuals are listed below.

-  Instruction Manual symbol: the product is marked with this symbol when it is necessary for the user to refer to the instrument manual.
-  Alternating current.
-  Direct current.
-  On (Supply).
-  Off (Supply).
-  In-position of push-button switch.
-  Out-position of push-button switch.
-  A chassis terminal; a connection to the instrument's chassis, which includes all exposed metal structure.
-  Stand-by.

---

|                |  |
|----------------|--|
| <b>WARNING</b> | <b>This warning sign denotes a hazard. It calls attention to a procedure, practice, or condition that, if not correctly performed or adhered to, could result in injury or death to personnel.</b> |
|----------------|--|

---

|                |  |
|----------------|--|
| <b>CAUTION</b> | This Caution sign denotes a hazard. It calls attention to a procedure, practice, or condition that, if not correctly performed or adhered to, could result in damage to or destruction of part or all of the instrument. |
|----------------|--|

---

|             |   |
|-------------|---|
| <b>NOTE</b> | This Note sign denotes important information. It calls attention to a procedure, practice, or condition that is essential for the user to understand. |
|-------------|---|

---

---

## **Certification**

Agilent Technologies certifies that this product met its published specifications at the time of shipment from the factory. Agilent Technologies further certifies that its calibration measurements are traceable to the United States National Institute of Standards and Technology, to the extent allowed by the Institution's calibration facility or by the calibration facilities of other International Standards Organization members.

---

## **Documentation Warranty**

The material contained in this document is provided "as is," and is subject to being changed, without notice, in future editions. Further, to the maximum extent permitted by applicable law, Agilent disclaims all warranties, either express or implied with regard to this manual and any information contained herein, including but not limited to the implied warranties of merchantability and fitness for a particular purpose. Agilent shall not be liable for errors or for incidental or consequential damages in connection with the furnishing, use, or performance of this document or any information contained herein. Should Agilent and the user have a separate written agreement with warranty terms covering the material in this document that conflict with these terms, the warranty terms in the separate agreement will control.

---

## **Exclusive Remedies**

The remedies provided herein are Buyer's sole and exclusive remedies. Agilent Technologies shall not be liable for any direct, indirect, special, incidental, or consequential damages, whether based on contract, tort, or any other legal theory.

---

## **Assistance**

Product maintenance agreements and other customer assistance agreements are available for Agilent Technologies products.

For any assistance, contact your nearest Agilent Technologies Sales and Service Office. Addresses are provided at the back of this manual.

---

## Typeface Conventions

Sample (bold)

Boldface type is used when a term is defined or emphasized.

*Sample* (Italic)

Italic type is used for emphasis and for titles of manuals and other publications.

**Sample** menu/button/box/tab

Indicates a menu/button/box/tab on the screen labeled “Sample” which can be selected/executed by clicking. “menu”, “button”, “box”, or “tab” may be omitted.

**[Sample]**

Indicates the hardkey whose key label is “Sample”.

**[Sample] > Item**

Indicates a series of key operations in which you press the **[Sample]** key, make the item called “Item” on the displayed menu blink by using the **[ ↓ ]** or in other ways, and then press the **[Enter]** key.

|   |    |
|---|----|
| <b>1. Introduction</b>  |    |
| Manuals for E5071C . . . . .  | 10 |
| Contents of This Manual . . . . .   | 10 |
| <b>2. Installation</b>  |    |
| Checking the Shipment . . . . .   | 13 |
| Environmental Requirements . . . . .  | 14 |
| Operating Environments . . . . .  | 14 |
| Ventilation Requirements . . . . .  | 15 |
| Protection Against Electrostatic Discharge (ESD) . . . . .  | 16 |
| Ensuring Adequate Free Space around Analyzer for Immediate Disconnection of Power Cable in Case of<br>Emergency . . . . . | 16 |
| Installing Front Handles/Rack Mounting Flanges . . . . .  | 17 |
| How to Install the Handle Kit (Option 1CN) . . . . .  | 18 |
| How to Install the Rack-mount Kit (Option 1CM) . . . . .  | 19 |
| How to Install the Rack-mount and Handle Kit (Option 1CP) . . . . .   | 19 |
| Connecting the Accessories . . . . .  | 20 |
| Connecting the BNC Adaptor (Option 1E5) . . . . .   | 20 |
| Connecting Mouse and Keyboard . . . . .   | 20 |
| Power Supply . . . . .  | 21 |
| Verification of the Power Supply . . . . .  | 21 |
| Verification and Connection of Power Cable . . . . .  | 21 |
| Starting the E5071C . . . . .   | 23 |
| Turning the Power ON and OFF . . . . .  | 23 |
| Disconnection from Supply Source . . . . .  | 24 |
| Removing / Mounting Removable Hard Disk (For Option 017 User) . . . . .   | 25 |
| Initial Registration of E5071C . . . . .  | 26 |
| Calibration of the Touch Screen . . . . .   | 28 |
| <b>3. Troubleshooting</b>   |    |
| Troubleshooting during Startup . . . . .  | 30 |
| System Recovery . . . . .   | 31 |
| Types of system recoveries . . . . .  | 31 |
| Notes on executing the factory recovery function . . . . .  | 31 |
| Procedure to execute the factory recovery . . . . .   | 32 |
| Procedure to create the user backup image . . . . .   | 35 |
| Procedure to execute the user recovery function . . . . .   | 41 |





---

# 1 Introduction

This chapter introduces the documentation for Agilent E5071C and the overview of this manual to use this manual efficiently. See this manual first when you use the E5071C for the first time.

## Manuals for E5071C

Agilent provides the following three manuals for E5071C. The latest version of all documentations can be downloaded from [http://www.agilent.com/find/ena\\_support/](http://www.agilent.com/find/ena_support/).

Installation Guide

The installation guide (this manual) provides start up setup information when you use the E5071C for the first time and troubleshooting information when the Windows cannot be boot up.

Online Help

The online help provides the information about the measurement operation, programming, built-in VBA, I/O interface. This is pre-installed in the E5071C. Press [Help] hard key on the front panel to open.

Service Guide

The service manual provides information about the parts, troubleshooting, performance test, adjustment and service menu.

---

## Contents of This Manual

The following shows the contents of this manual.

Chapter 1, “Introduction”

This chapter introduces the documentation for Agilent E5071C and the overview of this manual to use this manual efficiently. See this manual first when you use the E5071C for the first time.

Chapter 2, “Installation”

This chapter provides information about how to set up the Agilent E5071C.

Chapter 3, “Troubleshooting”

This chapter describes the troubleshooting during start up and the procedure of the operating system (OS) recovery when the Windows XP OS has been damaged.

---

## **2 Installation**

This chapter provides information about how to set up the Agilent E5071C.

### Contents of this Chapter

- ❑ **Checking the Shipment on page 13**

After you receive the analyzer, check all the items in the packing container.
- ❑ **Environmental Requirements on page 14**

Describes the system requirements needed to install the E5071C and how to secure space for heat radiation.
- ❑ **Installing Front Handles/Rack Mounting Flanges on page 17**

Shows how to mount the front handles used to transport the E5071C and how to install the flanges needed to install it in a rack.
- ❑ **Connecting the Accessories on page 20**

Provides information for connecting the mouse, keyboard, BNC adaptor to the E5071C.
- ❑ **Power Supply on page 21**

Shows how to check the power supply as well as check and connect the power cable.
- ❑ **Starting the E5071C on page 23**

Describes turning on/off of the Power switch and cutting off the power supply.
- ❑ **Initial Registration of E5071C on page 26**

Provides the procedure of initial registration for the Windows XP operating system of the E5071C.
- ❑ **Calibration of the Touch Screen on page 28**

Provides the procedure of touch screen calibration.

---

## Checking the Shipment

After you receive the analyzer, carry out checks during unpacking according to the following procedure.

---

### WARNING

**When unpacking the analyzer, if the external face of the analyzer (such as the cover, front/rear panel, LCD screen, power switch, and port connectors) appear to be damaged during transport, do not turn on the power switch. Otherwise, you may get an electric shock.**

- 
- Step 1.** Check that the packing box or shock-absorbing material used to package the analyzer has not been damaged.

---

### NOTE

If the packing box or shock-absorbing material has been damaged, leave the packing box and shock-absorbing material as is until other inspection items are checked as follows:

- Step 2.** Check the packaged items supplied with the analyzer for any damage or defects.
- Step 3.** By referring to the furnished contents list, check that all packaged items supplied with the analyzer have been provided as per the specified options.
- Step 4.** After checking, if one of the following applies, contact your nearest Agilent Technologies sales and service office.
1. The packing box or shock-absorbing material used to package the analyzer has been damaged or the shock-absorbing material has traces where extreme force has been applied.
  2. A packaged item supplied with the analyzer has mechanical damage or defects.
  3. A packaged item supplied with the analyzer is missing.
  4. A fault has been detected in the subsequent operation check of the analyzer.

If an abnormality is detected in step 1, contact the company that transported the analyzer as well as your nearest Agilent Technologies sales and service office. For inspection by the transport company, save the packing box, shock-absorbing material, and packaged items as you received them.

## Environmental Requirements

Set up the E5071C where the following environmental requirements are met.

### Operating Environments

Ensure that the operating environment meets the following requirements.

|   |   |
|---|---|
| Temperature                               | 5 °C to 40 °C   |
| Temperature range at the error-correction | 23 °C ± 5 °C (< 1 °C deviation from the temperature when performing the error-correction) |
| Humidity                                  | 20% to 80% at wet bulb temperature < +29 °C (non-condensation)                            |
| Altitude                                  | 0 to 2,000 m (0 to 6,561 feet)  |
| Vibration                                 | 0.21 G maximum, 5 Hz to 500 Hz  |

---

#### NOTE

Above environmental requirements are NOT for the specifications and measurement accuracy of the analyzer, but for the operating environment of the analyzer.

**Ventilation Requirements**

To ensure safety requirements, the specifications and measurement accuracy of the analyzer, you must keep environmental temperature within the specified range by providing appropriate cooling clearance around the analyzer or, for the rackmount type, by forcefully air-cooling inside the rack housing. For more information on environmental temperature to satisfy the specifications and measurement accuracy of the analyzer, see the specification in the *E5071C Online Help*.

When the environmental temperature around the analyzer is kept within the temperature range of the operating environment specification (See Section “Operating Environments” on page 14), the analyzer conforms to the requirements of the safety standard. Furthermore, under that temperature requirement, the analyzer still conforms to the requirements of the safety standard even when placing the analyzer with cooling clearance as follows:

|       | Requirements                  |
|-------|-------------------------------|
| Back  | ≥ 180 mm                      |
| Sides | ≥ 60 mm (both right and left) |

Figure 2-1

**Ventilation space at the installation**

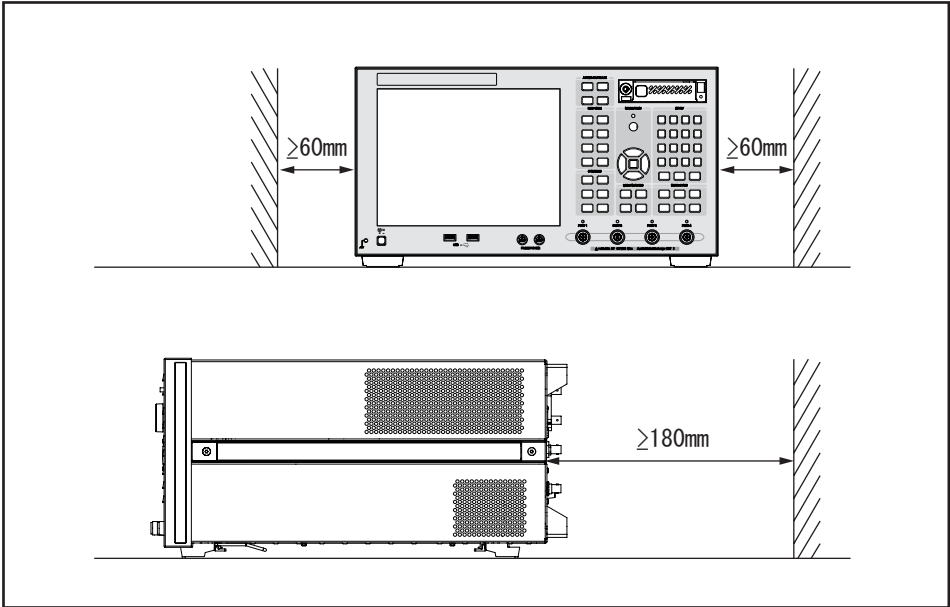

**NOTE**

Place the E5071C in a proper position as show in Figure 2-1.

## Protection Against Electrostatic Discharge (ESD)

Set up a static-safe work-station to protect the electronic components from the damage by the electrostatic discharge (ESD) as shown in Figure 2-2. Table 2-1 shows the accessories available that provide ESD protection.

**Table 2-1** The accessories available that provide ESD protection

| Name   | Agilent Part Number |
|--|---------------------|
| Static-control table mat and earth ground wire | 9300-0797           |
| Wrist-strap cord                               | 9300-0980           |
| Wrist-strap                                    | 9300-1383           |
| Heel-straps                                    | 9300-1169           |

**Figure 2-2** Example of the static-safe work station

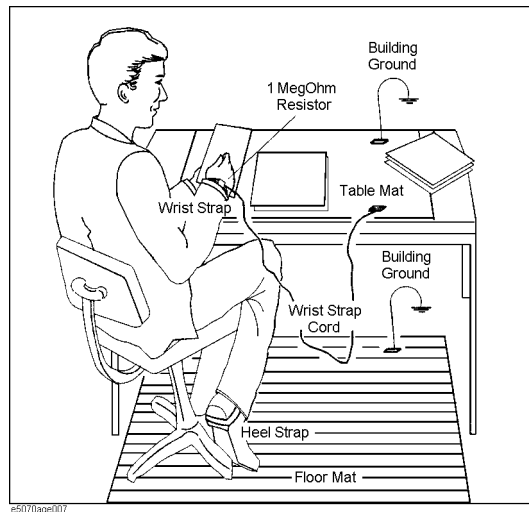

## Ensuring Adequate Free Space around Analyzer for Immediate Disconnection of Power Cable in Case of Emergency

As described in “Disconnection from Supply Source” on page 24, the power supply is disconnected by removing the power cable’s connector plug from either the AC outlet or the E5071C unit. When installing the E5071C, ensure that there is sufficient free space around the unit to permit quick disconnection of the plug (from AC outlet or E5071C unit) in case of emergency.



## Installing Front Handles/Rack Mounting Flanges

The E5071C can be installed on a workbench or in a rack. This section describes how to install the front handles (Option 1CN) used for moving or transporting the instrument, and how to install the analyzer in an equipment rack as part of a measurement system (Option 1CM: without the handles, Option 1CP: with the handles).

**Table 2-2**

**Agilent E5071C handles/rack mounting options**

| Option | Name                      | Agilent Part Number |
|--------|---------------------------|---------------------|
| 1CN    | Handle Kit                | 5063-9229           |
| 1CM    | Rack-mount Kit            | 5063-9216           |
| 1CP    | Rack-mount and Handle Kit | 5188-4430           |

**Table 2-3**

**Contents of each option**

| Option | Contents                                   | Quantity |
|--------|--|----------|
| 1CN    | Front Handles                              | 2        |
|        | Screws                                     | 6        |
|        | Trim Strips                                | 2        |
| 1CM    | Rack-mounting flanges (locking side plate) | 2        |
|        | Screws                                     | 6        |
| 1CP    | Rack-mounting flanges (locking side plate) | 2        |
|        | Front Handles                              | 2        |
|        | Screws                                     | 8        |

Figure 2-3 Installing front handle/rack-mount kits

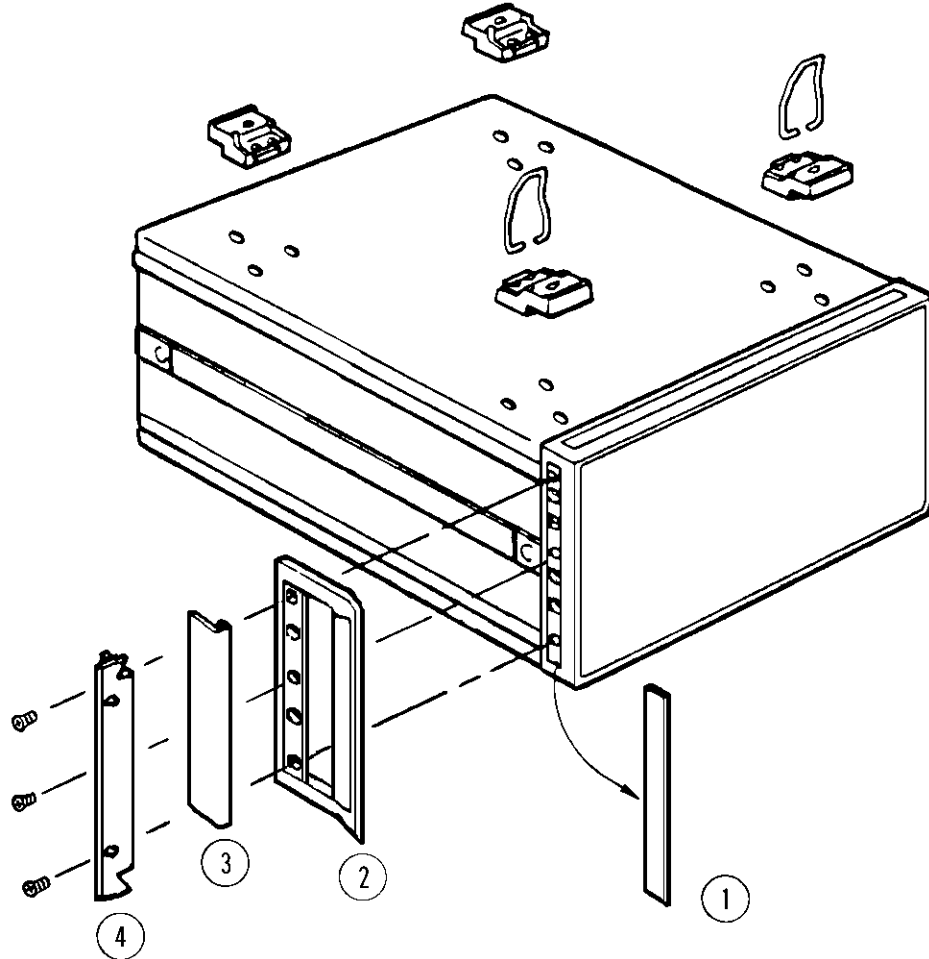

e5070aqj009

### How to Install the Handle Kit (Option 1CN)

The handle kit is used for transport and relocation of the E5071C. While referring to Figure 2-3, install the handle kit by following these steps.

- Step 1.** Remove the adhesive-backed trim strip (1) from each side of the outer frame of the E5071C front panel.
- Step 2.** Use the provided screws to mount the front handles (2) on each side of the E5071C front panel frame.
- Step 3.** Attach the provided modified trim strip (3) to each front handle in order to cover the front panel locking screws.

---

**WARNING**

If the installed front handle becomes damaged, replace it with a new one immediately. A damaged handle can break while moving or lifting the instrument and cause personal injury or damage to the instrument.

---

### How to Install the Rack-mount Kit (Option 1CM)

The rack-mount kit includes two flanges (locking side plates) for mounting the E5071C on a rack (482.6 mm/19 inches) conforming to the EIA Standard. While referring to Figure 2-3, install the rack-mount kit by following these steps.

- Step 1.** Remove the adhesive-backed trim strip (1) from each side of the outer frame of the E5071C front panel.
- Step 2.** Use the provided screws to mount a rack-mounting flange (4) on each side of the E5071C front panel frame.
- Step 3.** Remove the four bottom feet of the E5071C (lift the bar marked TAB on the inner side of the foot and slide the foot toward the bar).
- Step 4.** Mount the E5071C on the rack.

### How to Install the Rack-mount and Handle Kit (Option 1CP)

The rack-mount and handle kit includes both the rack-mounting flanges (locking side plates) and front handles. While referring to Figure 2-3, install the rack-mount kit by following these steps.

- Step 1.** Remove the adhesive-backed trim strip (1) from each side of the outer frame of the E5071C front panel.
- Step 2.** Use the provided screws to mount a front handle (2) and rack-mounting flange (4) on each side of the E5071C front panel frame.

---

**CAUTION**

Use both a front handle and a rack-mounting flange in the same time certainly. Do not attempt to install flanges or handles separately with hardware provided. Serious electrical damage will occur to the instrument.

---

- Step 3.** Remove the four bottom feet of the E5071C (lift the bar marked TAB on the inner side of the foot and slide the foot toward the bar).
- Step 4.** Mount the E5071C on the rack.

## Connecting the Accessories

You need to connect some accessories before use.

### Connecting the BNC Adaptor (Option 1E5)

When the E5071C is equipped with Option 1E5 (high-stability frequency standard), connect the BNC adaptor from the Ref Oven terminal to the Ref In terminal on the rear panel as shown in Figure 2-4. The BNC adaptor is included in Option 1E5. When Option 1E5 is installed, the frequency accuracy and stability of the E5071C will further improve.

Figure 2-4

#### Connecting the BNC adaptor

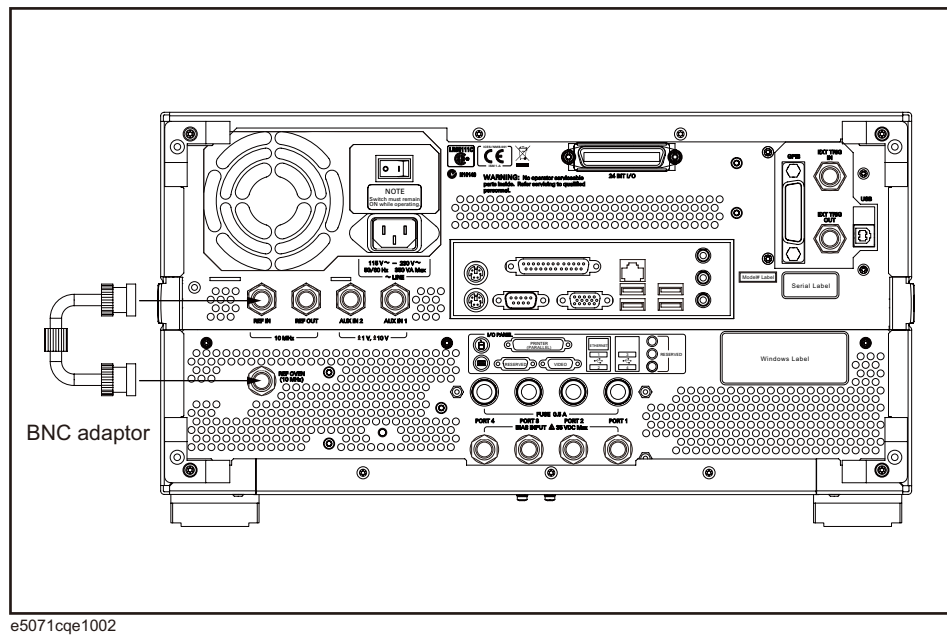

### Connecting Mouse and Keyboard

The E5071C allows you to connect Mouse and/or keyboard through USB or PS/2. USB mouse and keyboard can be connected with the USB ports on the front or rear panels.

Initial registration of the E5071C requires the mouse and keyboard before turning on the power.

## Power Supply

Before turning on the E5071C power, check the following.

### Verification of the Power Supply

Confirm that the power supplied to the E5071C meets the following requirements:

|                           | Requirements                                  |
|---------------------------|---|
| Voltage                   | 90 to 132 VAC or 198 to 264 VAC <sup>*1</sup> |
| Frequency                 | 47 to 63 Hz                                   |
| Maximum power consumption | 350 VA  |

\*1. Switched automatically by the E5071C in conformity to the voltage used.

### Verification and Connection of Power Cable

The three-wire power cable attached to the E5071C has one wire serving as a ground. Using this power cable allows the E5071C to be grounded, thereby protecting you against electrical shock from the power outlet.

**Step 1.** Confirm that the power cable is not damaged.

**WARNING** NEVER use a power cable showing any sign of damage. Faulty cables can cause electrical shock.



**Step 2.** Use the supplied cable to connect between the power cable receptacle (Figure 2-6 on page 24) on the rear panel of the E5071C and a three-wire power outlet with the grounding prong firmly connected in the ground slot.

**WARNING** Use the supplied power cable with grounding wire to securely ground the E5071C.

Figure 2-5 shows the power cable options.

Installation  
Power Supply

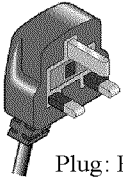
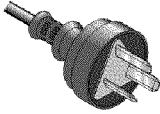
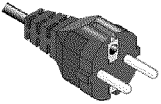
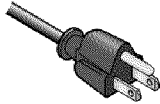
Figure 2-5 Power cable options

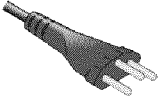
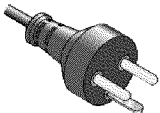
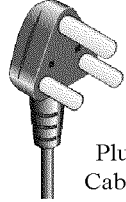
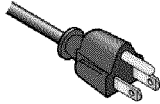
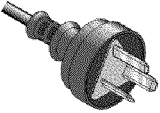
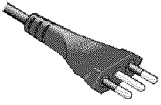
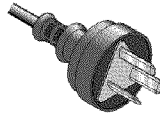
|   |  |
|---|--|
| <p>OPTION 900</p>  <p>United Kingdom</p> <p>Plug: BS 1363/A, 250V, 10A<br/>Cable: 8120-1351, 8120-8705</p>         | <p>OPTION 901</p>  <p>Australia/New Zealand</p> <p>Plug: AS 3112, 250V, 10A<br/>Cable: 8120-1369</p>                 |
| <p>OPTION 902</p>  <p>Continental Europe</p> <p>Plug: CEE 7 Standard Sheet VII, 250V, 10A<br/>Cable: 8120-1689</p> | <p>OPTION 903</p>  <p>U.S./Canada</p> <p>Plug: NEMA 5-15P, 125V, 10A<br/>Cable: 8120-1378</p>                        |
| <p>OPTION 904</p>  <p>U.S./Canada</p> <p>Plug: NEMA 6-15P, 250V, 6A<br/>Cable: 8120-0698</p>                       | <p>OPTION 906</p>  <p>Switzerland</p> <p>Plug: SEV Type 12, 250V, 10A<br/>Cable: 8120-2104</p>                       |
| <p>OPTION 912</p>  <p>Denmark</p> <p>Plug: SR 107-2-D, 250V, 10A<br/>Cable: 8120-2956</p>                        | <p>OPTION 917</p>  <p>India/Republic of S. Africa</p> <p>Plug: IEC 83-B1, 250V, 10A<br/>Cable: 8120-4211</p>       |
| <p>OPTION 918</p>  <p>Japan</p> <p>Plug: JIS C 8303, 125V, 12A<br/>Cable: 8120-4753</p>                          | <p>OPTION 920</p>  <p>Argentina</p> <p>Plug: Argentine Resolution 63, Annex IV, 250V, 10A<br/>Cable: 8120-6870</p> |
| <p>OPTION 921</p>  <p>Chile</p> <p>Plug: CEI 23-16, 250V, 10A<br/>Cable: 8120-6978</p>                           | <p>OPTION 922</p>  <p>China</p> <p>Plug: GB 1002, 250V, 10A<br/>Cable: 8120-8376</p>                               |
| <p>NOTE: Each option number includes a 'family' of cords and connectors of various materials and plug body configurations (straight, 90° etc.).</p>   |  |

power\_e

---

## Starting the E5071C



This section describes how to turn on/off the E5071C power and how to cut off the power supply in an emergency.

### Turning the Power ON and OFF

Perform the following steps to turn the power ON or OFF.

#### Turning the Power ON

**Step 1.** Confirm if the Line Switch on the rear panel is on. The switch should always be turned on.

**Step 2.** If the standby switch (  ) in the lower-left part of the front panel is in the depressed (  ) position, press it to put it in the popped up position (  ).

**Step 3.** Press the standby switch to put it in the depressed position (  ).



This operation turns ON the power, and the E5071C starts the self-test.

**Step 4.** Confirm that the self-test indicates normal operation.

Normal operation is confirmed by the self-test if no error message appears.

#### Turning the Power OFF

**Step 1.** Use either of the following methods to turn the power OFF.

- Press the standby switch (  ) in the lower-left part of the front panel (now in the pressed down (  ) position) to put it in the popped up (  ) position.
- Click Turn off Computer from Windows Start menu

These operations will start the E5071C shutdown process (required software and hardware processes for turning the power off), and the power will turn OFF after a few seconds.

---

#### NOTE

Under normal circumstances, always press the standby switch (  ), or click Turn off Computer from Windows Start menu, to execute the E5071C shutdown process. **Never cut off the power supply directly by disconnecting the power cable plug from the rear panel of the unit.**

If the power supply is cut off directly by disconnecting the power cable plug from the instrument or the AC outlet, the shutdown process is not carried out and there is a risk of damage to the E5071C's software or hardware.

Figure 2-6

Line switch (Always ON) and power cable receptacle

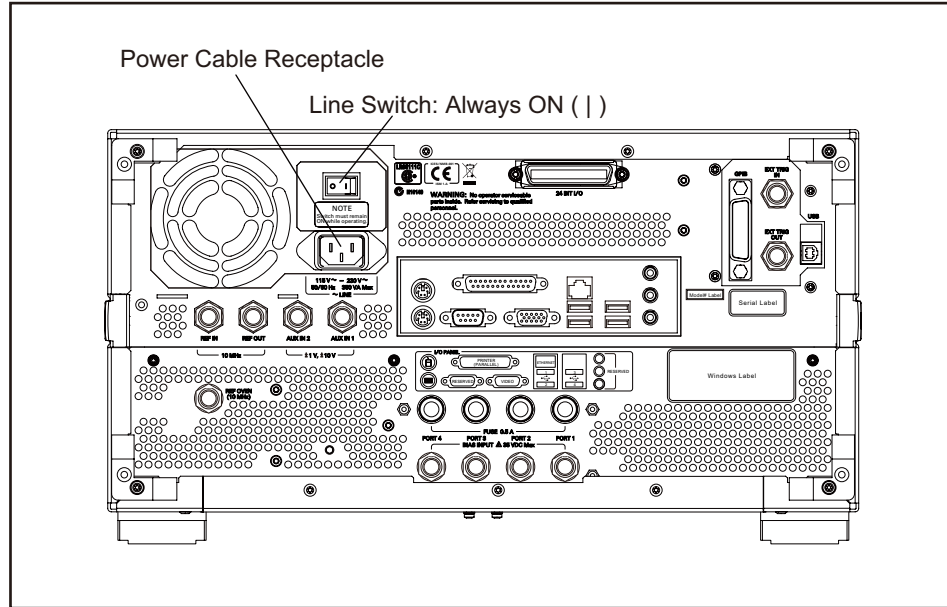

e5071cqe1003

### Disconnection from Supply Source

The power supply of the E5071C is cut off by disconnecting the plug of the power cable (on either AC outlet side or E5071C side). When it is necessary to disconnect the power supply in order to avoid shock hazards, etc., pull out the power cable plug from either the AC outlet side or the E5071C side.

---

#### NOTE

To allow this operation to be performed smoothly, be sure to follow the guidelines in “Ensuring Adequate Free Space around Analyzer for Immediate Disconnection of Power Cable in Case of Emergency” on page 16.

When turning the power OFF under normal circumstances, always follow the methods described in “Turning the Power OFF” on page 23.

---



## Removing / Mounting Removable Hard Disk (For Option 017 User)

For details of removing / mounting removable hard disk, refer to the following website.

<http://ena.tm.agilent.com/e5071c/manuals/webhelp/eng/>

---

## Initial Registration of E5071C

When you start up the E5071C at the first time, you need to perform the initial registration of the Windows XP operating system of the E5071C.

---

**NOTE** You cannot use the front panel keys during the initial registration of the E5071C therefore connect the mouse and the keyboard before turning on the power.

---

**NOTE** If you perform the following procedure incorrectly, a message asking you whether to return to the previous registration screen and perform the registration appears. In this case, follow the instruction to return to the previous registration screen.

---

**Step 1.** Turns on the E5071C.

**Step 2.** The Windows XP Professional Setup wizard appears. Click the **Next >** button (Figure 2-7).

**Figure 2-7** Windows XP Professional Setup wizard



e5071cse1073

**Step 3.** In the Windows XP Professional Setup dialog box, select the **I accept this agreement** box and click the **Next >** button (Figure 2-8).

**Figure 2-8** Windows XP Professional Setup dialog box (1/2)

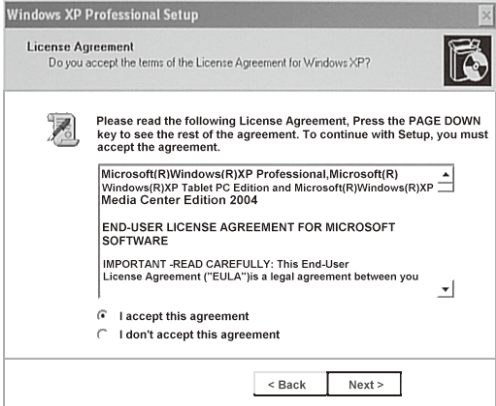

**Step 4.** In the next dialog box , input **agena** in the **Name** box. Then, click the **Next>** button (Figure 2-9).

**Figure 2-9** Windows XP Professional Setup dialog box (2/2)

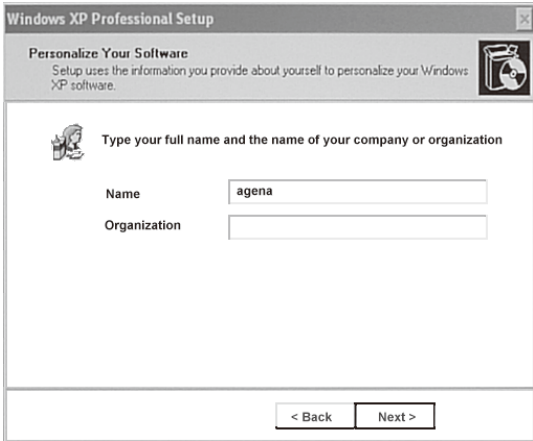

**Step 5.** After a while, the E5071C restart automatically. Then, the measurement display appears.

---

## Calibration of the Touch Screen

After E5071C measurement screen appears, you have to calibrate the touch screen. Follow the procedure described below to calibrate the touch screen.

- Step 1.** Press **System**.
- Step 2.** Press **Service Menu**.
- Step 3.** Press **Test Menu**.
- Step 4.** Press **Adjust Touch Screen**.

The touch screen calibration screen (Figure 2-10) appears.

**Figure 2-10**

### Touch Panel Calibration Screen

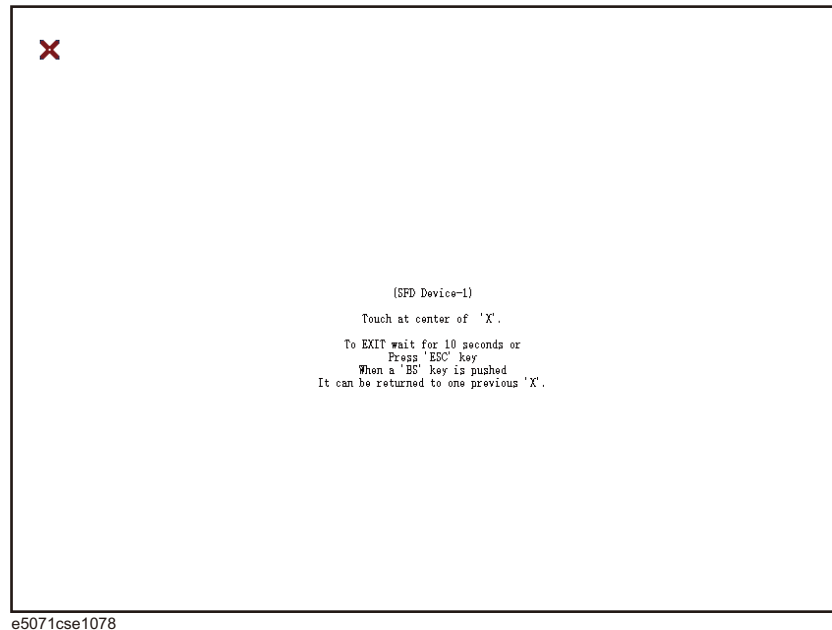

- Step 5.** Touch the x mark on the upper left with your finger. The mark x appears also on the upper right, lower left, and lower right. Touch the x marks in that order with your finger.

Touching the four locations described above with your finger automatically concludes the touch screen calibration.

---

#### **NOTE**

With no operation on the touch screen calibration screen for a preset time, it automatically closes and the previous measurement screen reappears.

---

## 3 Troubleshooting

This chapter describes the troubleshooting during start up and the procedure of the operating system (OS) recovery when the Windows XP OS has been damaged.

---

## Troubleshooting during Startup

When you encounter the problem during start up, see Table 3-1. System recovery saves most of problems.

**Table 3-1**

### Troubleshooting during startup

| Symptom   | Solution  |
|---|---|
| Turning on (I) the standby switch does not start up the system.   | Confirm that the power cable is properly plugged in.<br>Confirm that the line switch on the rear panel is turned on |
| The system starts up, but it automatically shuts down immediately.  | Execute the system recovery.  |
| The system starts up, but it enters the service mode (The instrument status bar in the lower right part of the screen displays SVC in red).   |   |
| The measurement screen appears after startup, but the power-on test is failed, with Error Message 241 appearing against a red background in the instrument message/warning area in the lower left part of the screen. |   |

## System Recovery

By executing system recovery, you can return the system of the E5071C (the Windows operating system and the firmware) to the factory state (at the time of purchase<sup>\*1</sup>).

### CAUTION

Strictly follow the steps described below. If you do any operation other than the following steps, the system may not be recovered.

### Types of system recoveries

The following 2 types of system recoveries are available.

Factory recovery

Returns the contents of the C drive to the factory state.

User recovery

Returns the contents of the C and D drives to a user-specified state. To use this function, you must prepare for recovery in advance. For information on the preparation, see “Procedure to create the user backup image” on page 35 for information on the execution, see “Procedure to execute the user recovery function” on page 41.

### Notes on executing the factory recovery function

Executing the factory recovery function causes the following conditions:

- In addition to the Windows operating system and the firmware, the following settings of the E5071C are returned to the factory state.
  - Network setting
  - GPIB setting
  - Printer setting
- The driver for the supported printer installed after purchase is deleted.
- You need to execute initial registration again.

Files you created using the save function (files in the D drive) are not affected, but we recommend backing them up before executing system recovery for precautionary purposes. For more information on backup, refer to “Backing Up the Data” as described in E5071C Online Help.

<sup>\*1</sup>. If the hard disk failed and has been replaced after purchase, the state when the replacement was performed is recovered.

### Procedure to execute the factory recovery

This section describes how to return the contents of the C drive to the factory state.

---

**NOTE** You need a keyboard for this operation.

- Step 1.** Shut down the E5071C.
- Step 2.** Disconnect all of the USB device from the USB ports.
- Step 3.** Connect the keyboard to the E5071C.
- Step 4.** Press the standby switch of the E5071C to turn it on.
- Step 5.** When the screen as shown in the figure below appears, press **F11** of the keyboard.

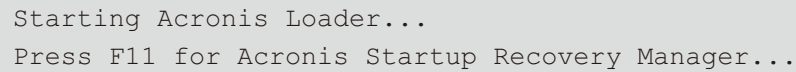

```
Starting Acronis Loader...  
Press F11 for Acronis Startup Recovery Manager...
```

e5071cse1055

---

**CAUTION** Press F11 only once. If you press F11 twice or more and a screen which is not mentioned in this manual appears, reboot the instrument and restart the process from the first.

---

**NOTE** After several seconds, the next screen appears automatically even if you do not press any key, so do not miss it.

---

**NOTE** After Step 5, if the E5071C freezes with the cursor does not blink, turn the off and remove unnecessary USB devices. Then, replace the keyboard with a PS/2 keyboard to execute the process again.

---



**Step 6.** Select **Restore**.

**Figure 3-1**                    **Activate Acronis Startup Recovery Manager**

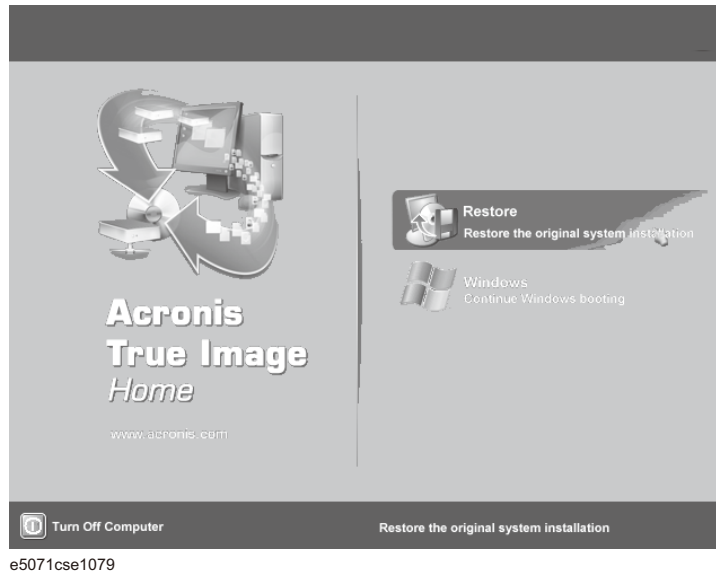

**Step 7.** A confirmation dialog box is displayed. Push the enter to select **Yes** to start the recovery of the factory backup. The recovery takes a few minutes depending on the amount of data.

**Figure 3-2**                    **Recover Factory Backup**

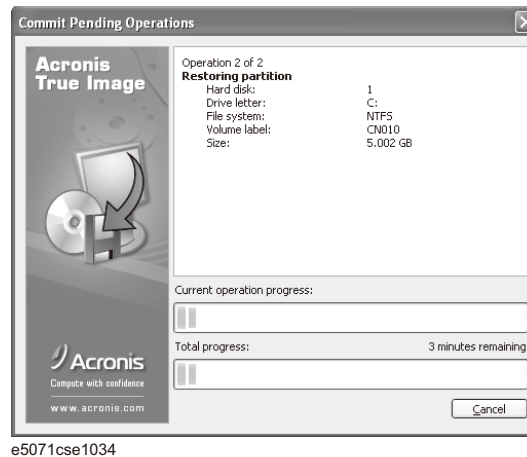

**Step 8.** When the recovery is finished, push the enter select OK. The E5071C restarts automatically.

**Step 9.** After restart, the screen for initial registration appears. Execute initial registration. For information on the execution procedure, refer to “Initial Registration of E5071C” on page 26.

**Step 10.** Execute the calibration of the touch screen. For information on the execution procedure, refer to “Calibration of the Touch Screen” on page 28.

---

**CAUTION** Never turn off the power during the system recovery because doing so may cause serious damage to the E5071C.

---

## Procedure to create the user backup image

This section describes how to create the user backup image. The C and D drives' contents saved in this procedure are recalled when the user recovery function is executed.

- Step 1.** Close the E5071C application by pressing **System** > Service Menu > Exit.
- Step 2.** Close all other applications you currently open.
- Step 3.** From the Windows start menu, select All Programs > Acronis > Acronis True Image.
- Step 4.** Click “No, Thanks” button.

Figure 3-3

### Recover User Backup

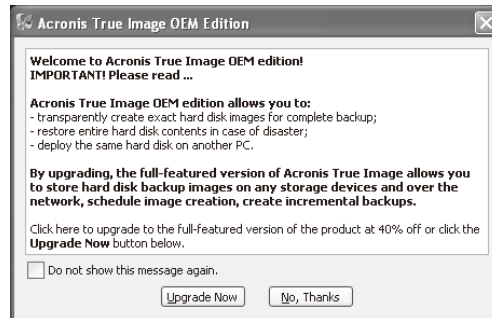

e5071cse1080

- Step 5.** Click **Backup**

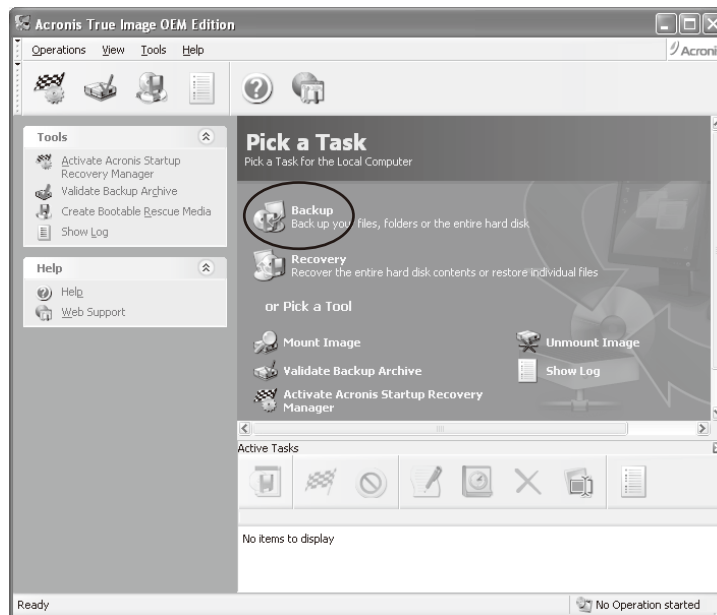

e5071cse1125

## Troubleshooting System Recovery

**Step 6.** Click **Next** button.



e5071cse1126

**Step 7.** Select “The entire disk contents or individual partition,” then click **Next** button.



e5071cse1127

**Step 8.** Select the C drive and D drive.

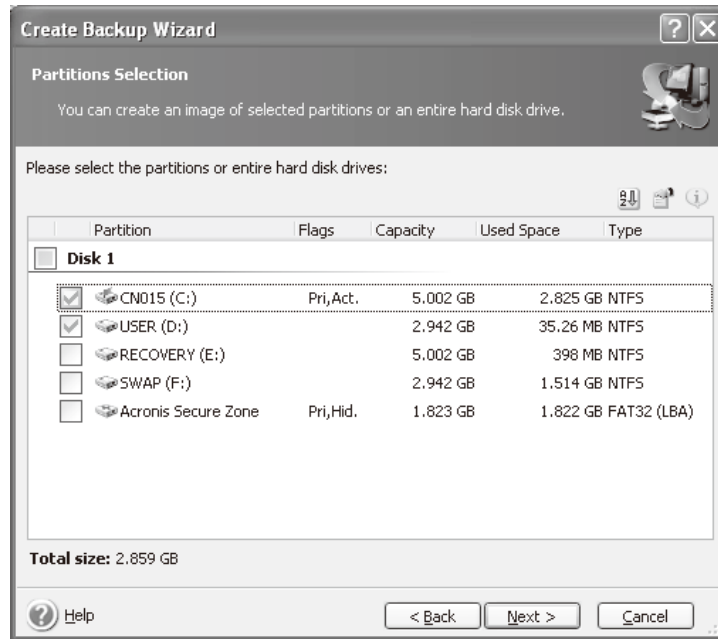

e5071cse1128

**Step 9.** Select the destination folder and input a file name, then click **Next** button. It is recommended to save the file to a directory which has enough space like the E drive. Also, never save the contents of the drive to the C, D or F drive.

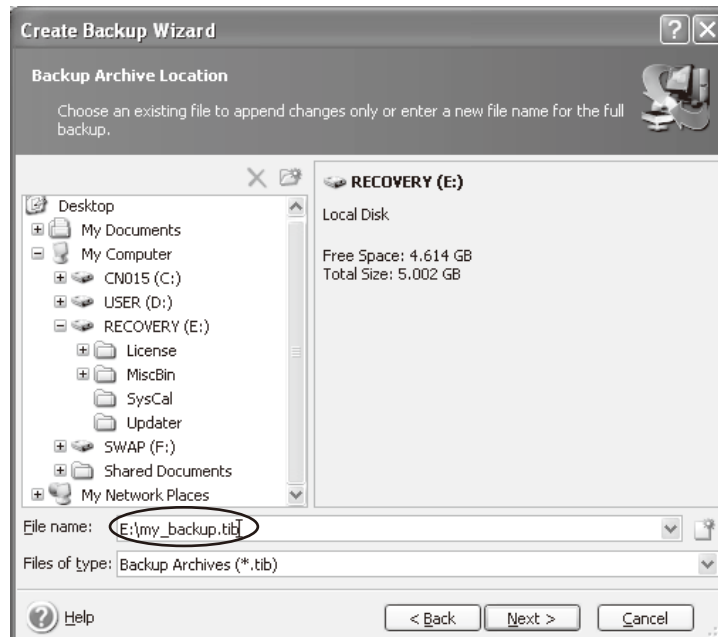

e5071cse1129

## Troubleshooting System Recovery

**Step 10.** Select “Set the options manually” and click **Next** button.

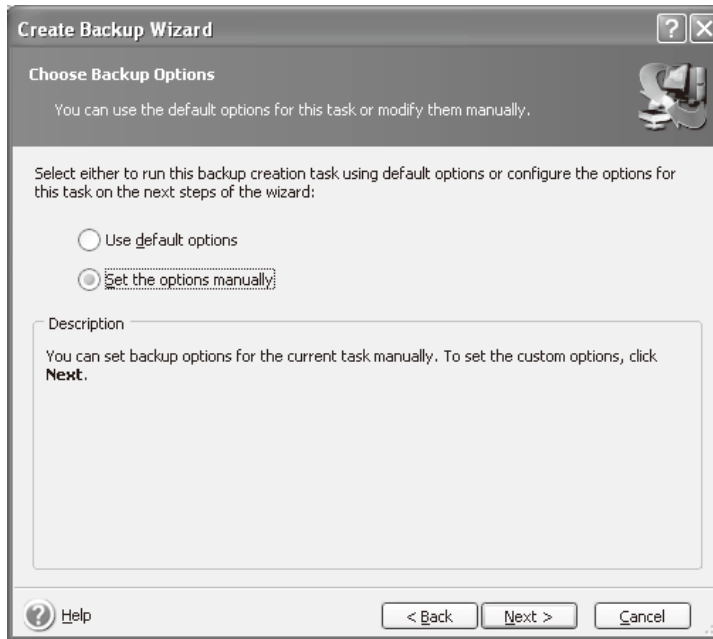

e5071cse1130

**Step 11.** Select “Backup priority” in the left field and “High” in the right field, then click **Next** button.

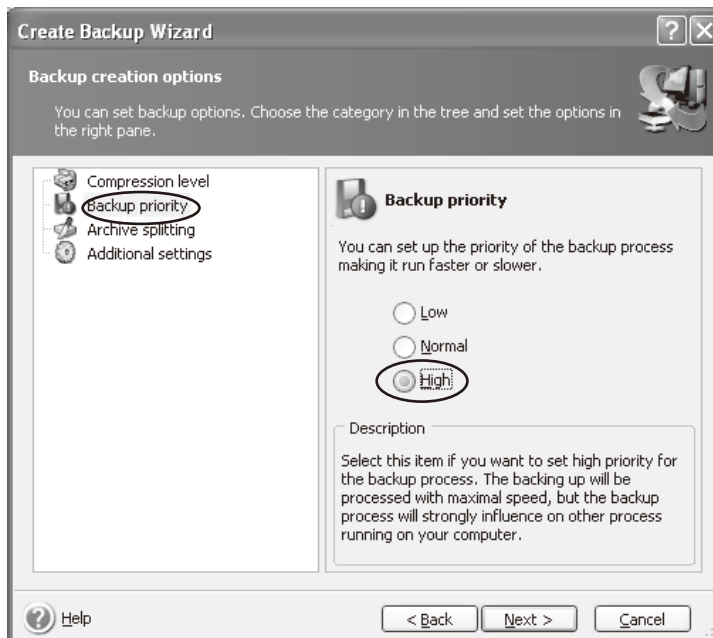

e5071cse1131

**Step 12.** If necessary, input comments and click **Next** button. The comments can be omitted.

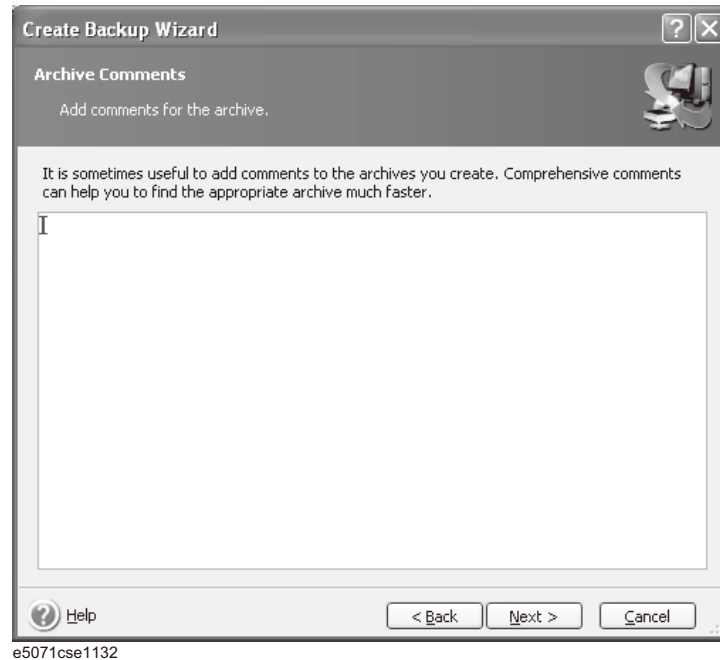

**Step 13.** Click **Proceed** button.

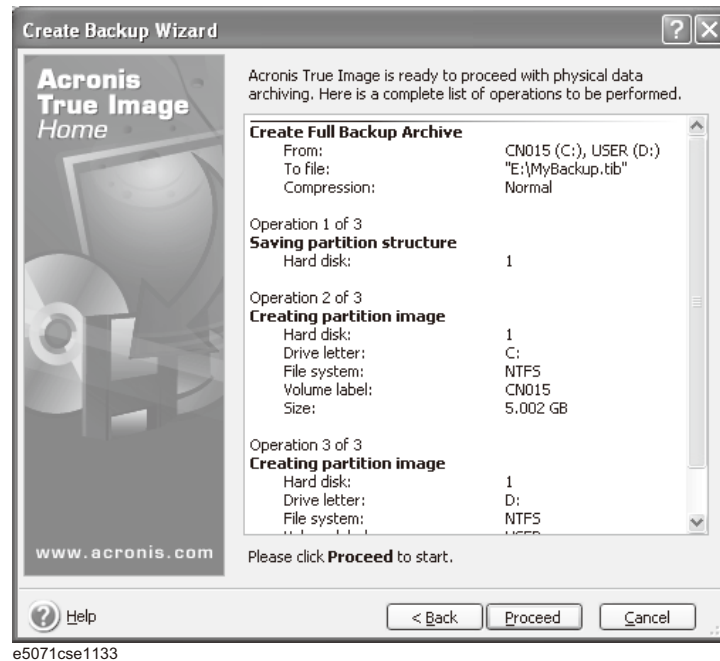

**Step 14.** The following screen appears during backup.

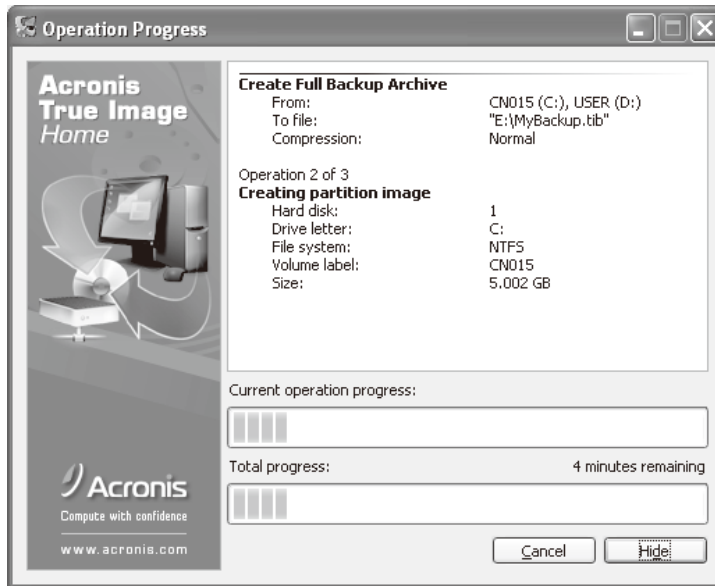

e5071cse1134

**Step 15.** The following screen appears when the user backup image was created. Click **OK**.

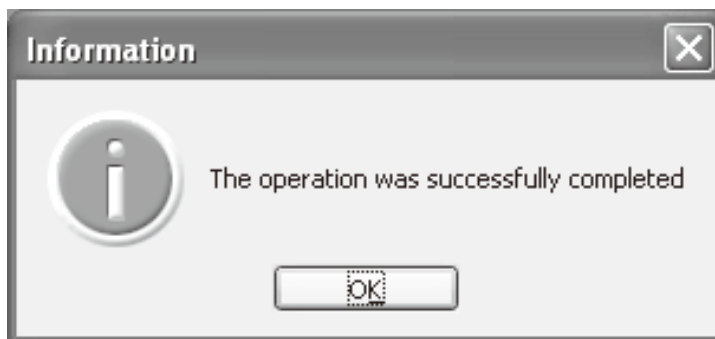

e5071cse1135

---

**CAUTION**

Never turn off the power during creating the user backup image because doing so may cause serious damage to the E5071C.



## Procedure to execute the user recovery function

Returns the contents of the C and D drives to a user-specified state. To use this function, you must create the user backup image in advance. For more information, see the description “Procedure to create the user backup image” on page 35.

- Step 1.** Close the E5071C application by pressing **System** > Service Menu > Exit.
- Step 2.** Close all other applications you currently open.
- Step 3.** From the Windows start menu, select All Programs > Acronis > Acronis True Image.
- Step 4.** Click “No, Thanks” button.

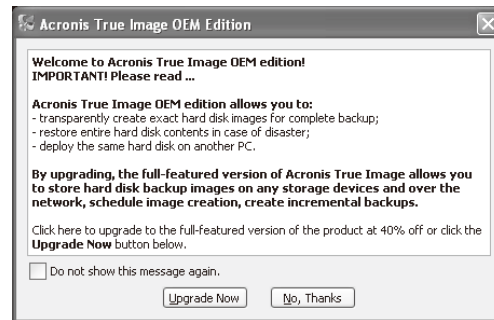

e5071cse1080

- Step 5.** Click **Recovery**.

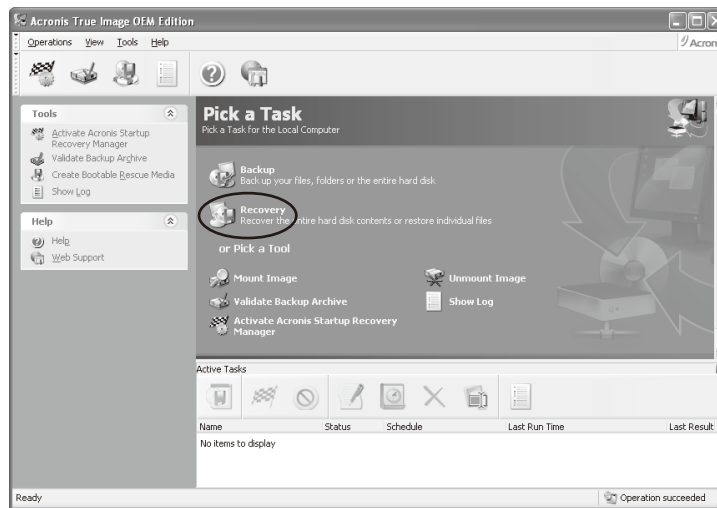

e5071cse1136

## Troubleshooting System Recovery

**Step 6.** Click **Next** button.



e5071cse1137

**Step 7.** Select the saved backup image file, then click **Next** button.

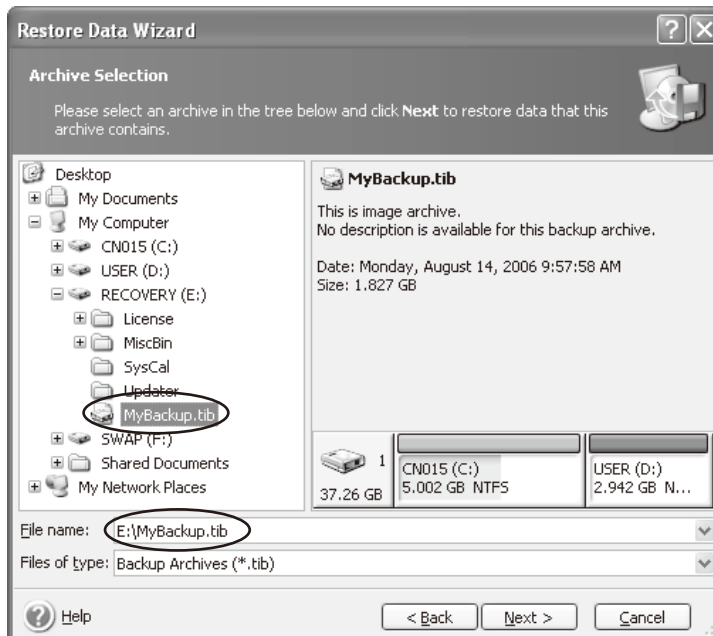

e5071cse1138

**Step 8.** Select “Restore disks or partitions,” then click **Next** button.

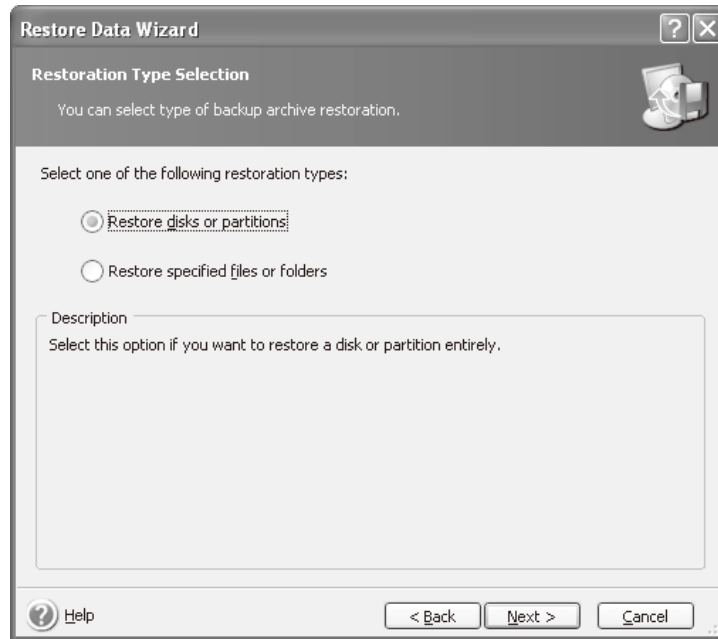

e5071cse1139

**Step 9.** Select the C drive, then click **Next** button.

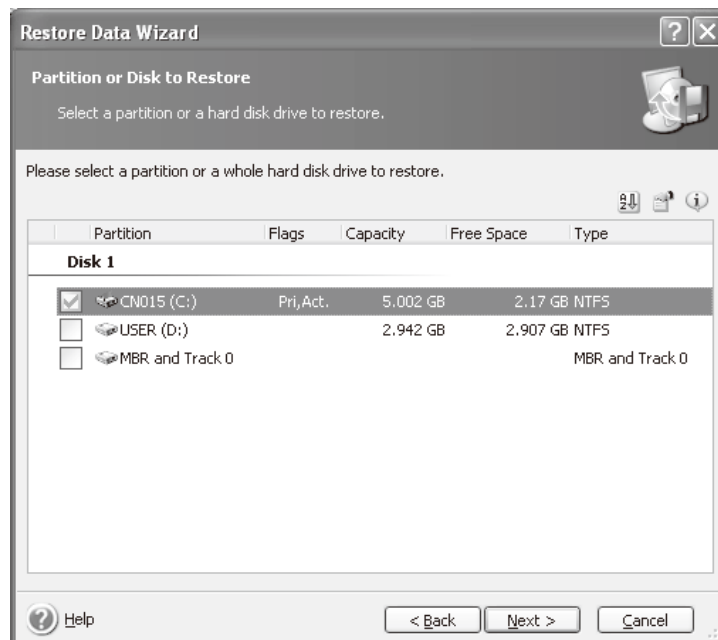

e5071cse1143

## Troubleshooting System Recovery

**Step 10.** Select the C drive to restore, then click **Next** button.

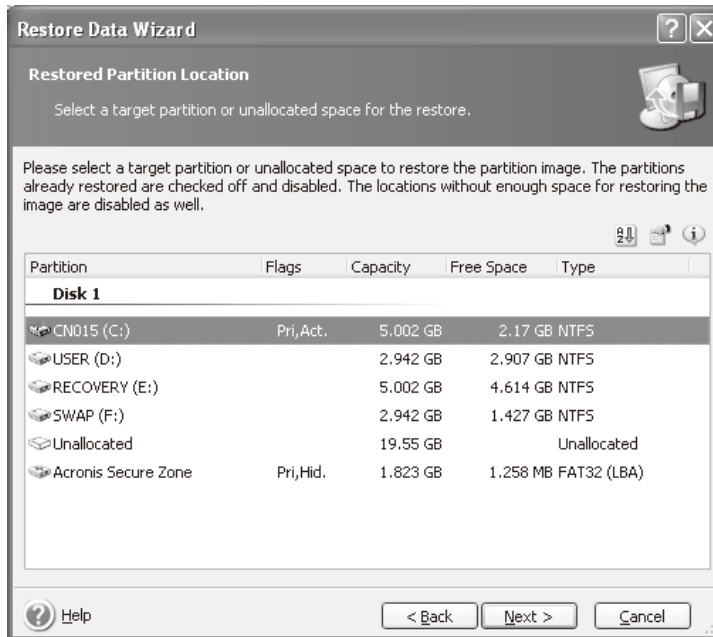

e5071cse1144

**Step 11.** Select “Active” and click **Next** button.



e5071cse1145

**Step 12.** Click **Next** button.

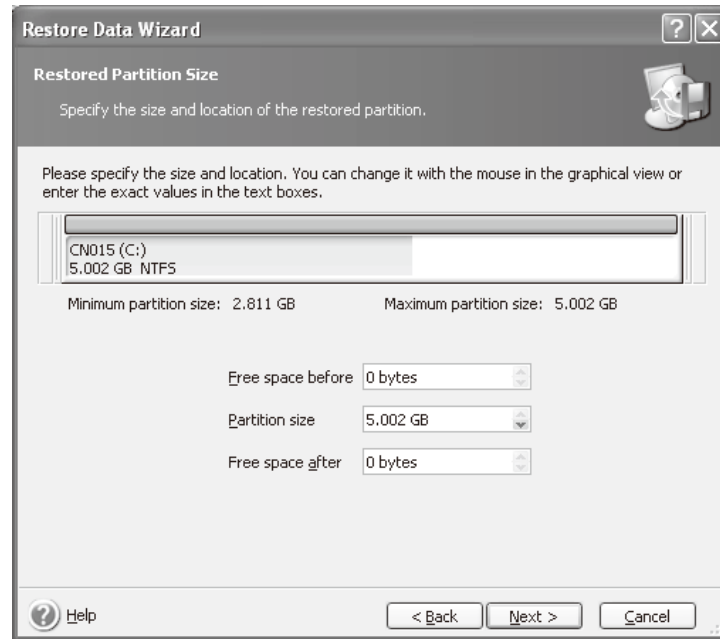

e5071cse1146

**Step 13.** Select “Yes, I want to assign a logical drive letter to the restored partition” and click **Next** button.

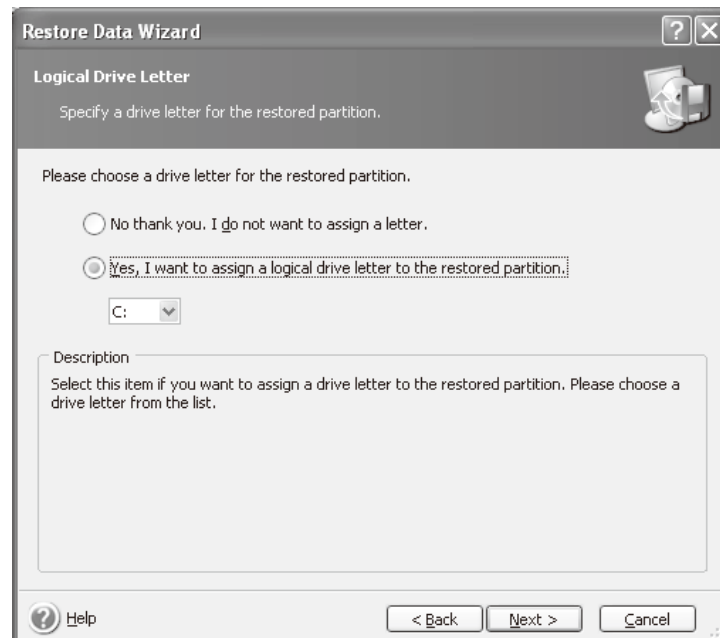

e5071cse1147

## Troubleshooting System Recovery

**Step 14.** Select “Yes, I want to restore another partition or hard disk drive,” then click **Next** button.



e5071cse1148

**Step 15.** Select the D drive to restore, then click **Next** button.

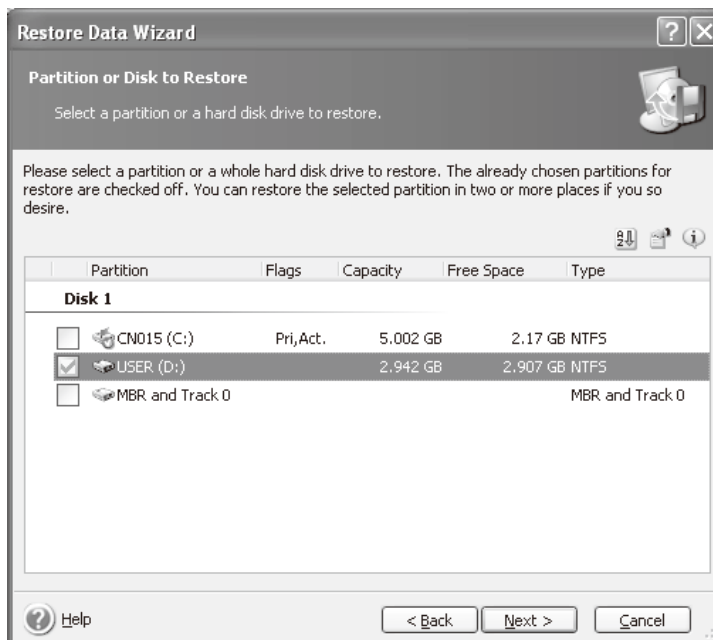

e5071cse1149

**Step 16.** Select the D drive to restore, then click **Next** button.

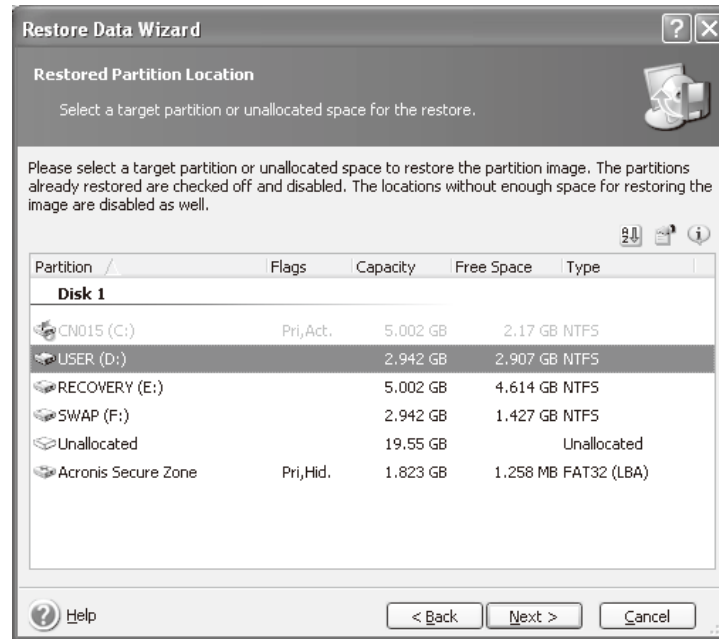

e5071cse1150

**Step 17.** Select “Logical” and click **Next** button.



e5071cse1151

## Troubleshooting System Recovery

**Step 18.** Click **Next** button.

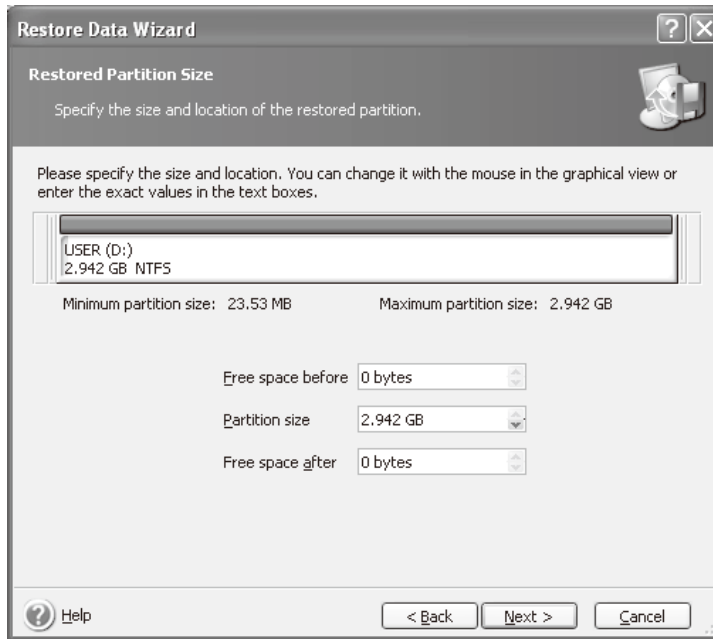

e5071cse1152

**Step 19.** Select “Yes, I want to assign a logical drive letter to the restored partition,” then click **Next** button.

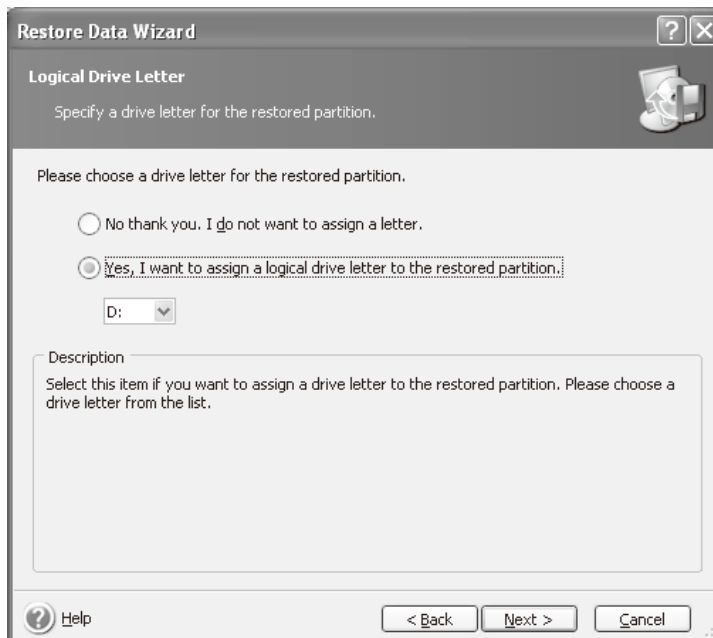

e5071cse1153



**Step 20.** Select “No, I do not.” and click **Next** button.



e5071cse1154

**Step 21.** Select “Set the options manually” and click **Next** button.



e5071cse1155

**Step 22.** Select “Restoration Priority” in the left field and “High” in the right field, then click **Next**

button.

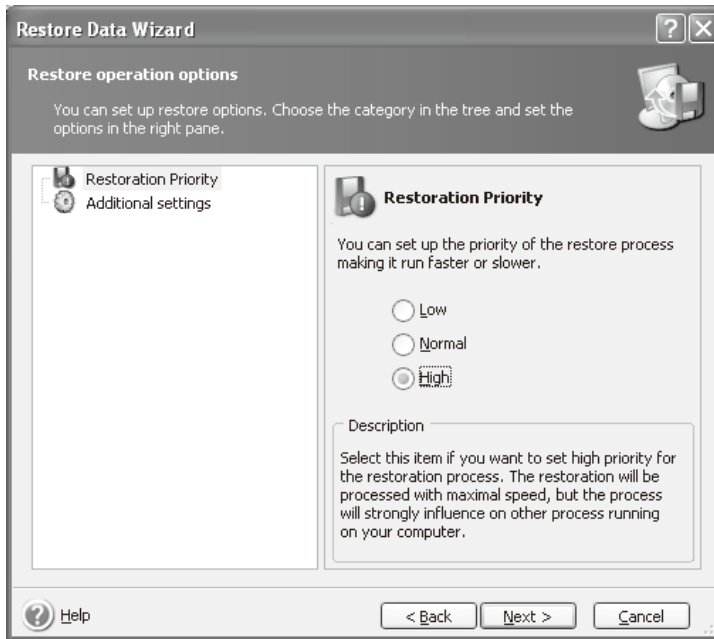

e5071cse1156

**Step 23.** Click **Proceed** button.

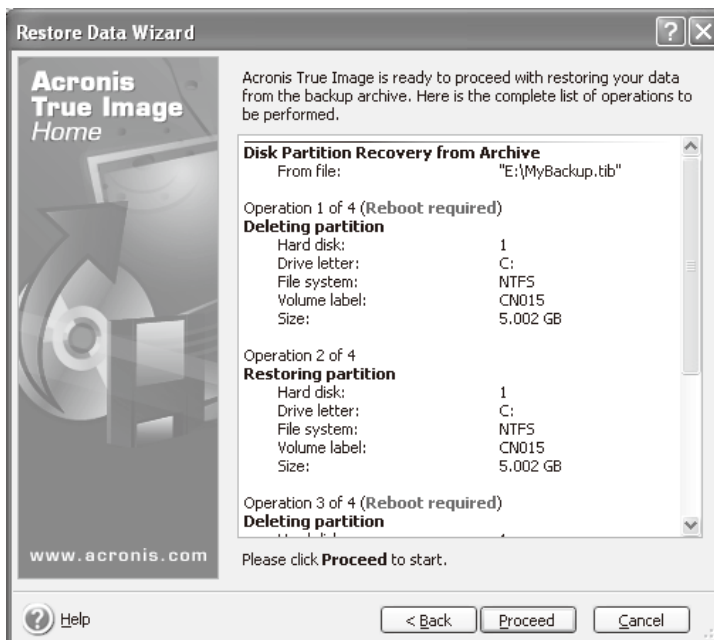

e5071cse1157

**Step 24.** Click **Reboot** button.

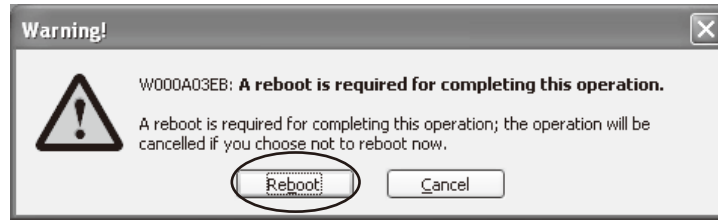

e5071cse1158

---

**CAUTION**

**Never turn off the power during the recovery of the user backup image because doing so may cause serious damage to the E5071C.**

**Step 25.** After boot up, perform “Initial Registration of E5071C” on page 26 and “Calibration of the Touch Screen” on page 28.



# REGIONAL SALES AND SUPPORT OFFICES

*For more information about Agilent Technologies test and measurement products, applications, services, and for a current sales office listing, visit our web site: <http://www.agilent.com/find/tmdir>. You can also contact one of the following centers and ask for a test and measurement sales representative. 21/01/2004*

## **United States:**

Test and Measurement Call Center  
(tel) 1 800 452-4844  
(fax) 1 888 900-8921

## **Australia/New Zealand:**

(tel) (61 3) 9210-5555 (Australia)  
(fax) (61 3) 9210-5899  
(tel) (64 4) 939-0636 (New Zealand)  
(fax) (64 4) 972-5364

## **Canada:**

Test and Measurement Call Center  
(tel) 1 877 894-4414  
(fax) 1 888 900-8921

## **Asia Pacific:**

(tel) (65) 6375-8100  
(fax) (65) 6836-0252  
Email: [tm\\_asia@agilent.com](mailto:tm_asia@agilent.com)

## **China:**

(tel) 800 810-0189  
(fax) 800 820-2816

## **Europe:**

(tel) (31 20) 547-2323  
(fax) (31 20) 547-2390

## **Japan:**

Call Center  
(tel) 0120 421-345  
(tel) (81) 426 56-7832  
(fax) (81) 426 56-7840

## **Korea:**

(tel) (82 2) 2004-5004  
(fax) (82 2) 2004-5115

## **Latin America:**

(tel) (305) 269-7500  
(fax) (305) 269-7599

## **Taiwan:**

(tel) 0800 047 866  
(fax) 0800 286 331